

Aimpoint®

Acro C-1™ User manual



THE FUTURE IN SIGHT.

1 PRESENTATION

Aimpoint® red dot sights are designed for the "two eyes open" method which greatly enhances situational awareness and target acquisition. Thanks to the optical design the red dot follows the movement of the user's eye while remaining fixed on target, eliminating any need for centering.

1.1 Technical specification

Optical system

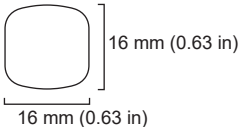
Magnification	1X
Eye relief	Unlimited
Clear aperture	
NVD ² compatible	Yes
Optical coating	Anti-reflex (AR) coating
Adjustments	1 click = 17 mm at 100 m = 0.6 in at 100 yds
Adjustment range (windage and elevation)	±1 m at 100 m ±1 yds at 100 yds
Dot size	3.5 MOA ¹

Dot intensity settings	10 settings manually adjusted with push-buttons. Setting 1-2 for use with NVD and setting 3-10 for use in daylight.
------------------------	---

Signature	No forward optical signature from the dot beyond 10 meters
-----------	--

Power source

Battery type	CR1225 (3.0 V) Lithium
Battery life ³	More than 1.5 years of use on setting 6, more than 8 years on NVD-setting (1-2).

Size (L × W × H)

Sight	47 mm × 30 mm × 30 mm (1.9 in × 1.2 in × 1.2 in)
-------	---

Weight

Sight (incl. battery)	60 g (2.1 oz)
-----------------------	---------------

Height of optical axis

Sight with integrated mount

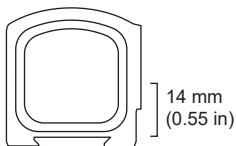

Materials

Sight housing	High strength aluminum, black to dark gray, non-glare finish
Push-buttons	Silicone rubber, black, non glare finish

Environmental specification

Temperature range (operation)	-30 °C to +60 °C (-22 °F to +140 °F)
Water resistance	5 m (15 ft)

1 MOA: Minute Of Angle, 1 MOA \approx 30 mm at 100 m or \approx 1" at 100 yds

2 NVD: Night Vision Device

3 Battery life: Values valid at room temperature for a quality battery

1.2 Overview

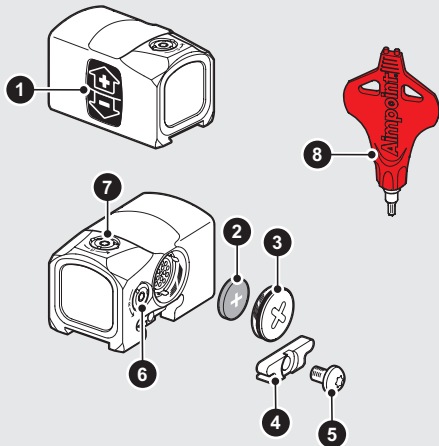

Fig. 1 Overview

- | | |
|-------------------------|------------------------------|
| 1 Push-buttons | 6 Windage adjustment screw |
| 2 Battery (CR1225) | 7 Elevation adjustment screw |
| 3 Battery cap | 8 Aimpoint tool |
| 4 Locking bar | |
| 5 Screw for locking bar | |

2 OPERATION

WARNING: Ensure the weapon is not loaded and the safety selector is in the "safe" position before attempting to install, remove or perform maintenance.

2.1 Install battery

- a Unscrew and remove the battery cap (3) using a flat head screwdriver or similar.
- b Insert battery (2) with the positive end (+) toward the battery cap (3) and the negative end toward the sight as shown in Fig. 1.

CAUTION: Check that the o-ring on the battery cap is in position and in good condition to ensure there is no water leakage into the battery compartment.



- c Tighten the battery cap (3). When resistance is encountered, proceed to tighten until the battery cap (3) is fully tightened.

NOTE: For storage of the sight, remove the battery.

2.2 Turn ON / OFF and adjust red dot intensity

- Press  or  to turn the sight **ON**.

NOTE: The sight will always turn **ON** at setting 7 of 10.

- Hold  to turn the sight **OFF**.
- Press  or  to adjust red dot intensity.

NOTE: Intensity setting 1-2 are intended for use with NVD and intensity setting 3-10 for use in daylight.

2.3 Install the sight

To install the sight to an interface compatible with the integrated mount shown in Fig. 1, follow the described procedure:

- a Loosen the screw (5) using the Torx T10 of the Aimpoint tool (8) and clamp the locking bar (4) around the dovetail interface.
- b With the recoil stop positioned in the recess, push the sight forward (toward muzzle) and tighten the screw (5).
- c Tighten the screw (5) until a light resistance is encountered. Proceed with another 1/4 to 1/2 turn until fully tightened (3 Nm / 2.2 ft·lb).
- d Retighten the screw (5) after initial firing to ensure the sight is securely fastened.

CAUTION: Do not overtighten.

2.4 Zeroing

CAUTION: Do not continue to adjust windage and elevation screws (6) (7) if you encounter resistance.

- a Adjust the intensity to a comfortable setting for the red dot to contrast clearly against the target.
- b Use the Torx T10 of the Aimpoint tool (8) to turn the adjustment screws (6) (7).
- c Windage adjustments (see Fig. 3):
 - Turn windage adjustment screw (6) counterclockwise to move point of impact to the right (R).
 - Turn windage screw (6) clockwise to move point of impact to the left.
- d Elevation adjustments (see Fig. 4):
 - Turn elevation adjustment screw (7) counterclockwise to move point of impact up (U).
 - Turn elevation adjustment screw (7) clockwise to move point of impact down.
- e Confirm zeroing by firing at least three shots at a zeroing target. Check points of impact to confirm accuracy and repeat zeroing procedure if required.
- f Ensure the sight is securely installed on the weapon and retighten the screw (5) if necessary.

NOTE: Each click of the adjustment screws (6) (7) corresponds to approximately 17 mm movement of point of impact at 100 m or 0.6 in at 100 yds.

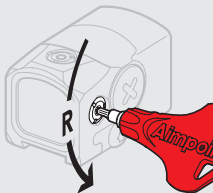

Fig. 3 Windage adjustments

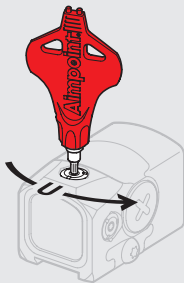

Fig. 4 Elevation adjustments

3 EXTREME CONDITIONS

- Extreme heat (moist or dry): no special procedures required.
- Extreme cold: extreme cold might shorten battery life.
- Salt air: no special procedures required.
- Sea spray, water, mud and snow: ensure the battery cap (3) is tightened before exposing the sight to sea spray, mud, snow or before submerging the sight in water. Clean lenses with lens paper/cloth and wipe the sight dry as soon as possible after exposure to water, sea spray, mud or snow.
- Dust storms and sand storms: no special procedures required.
- High altitudes: no special procedures required.

CAUTION: Never clean the lenses with fingers. Use lens paper/cloth. If lens paper/cloth is not available:

- To clear away debris (sand, grass etc.): blow away the dirt or rinse with clear water.
- To clean lenses: fog the lenses or rinse with clear water and clean them with a soft piece of cloth.

4 TROUBLESHOOTING

The red dot does not appear or has disappeared

Make sure contact surfaces in the battery compartment are clean and verify that a working battery (CR1225) is installed correctly according to 2.1. If the sight is malfunctioning, notify local dealer/armourer.

The sight is impossible to zero

If an adjustment screw (6) or (7) is at its limit, check the alignment of mount and barrel. If point of impact is moving, check if the sight is securely installed on the weapon and check weapon rail (or carry handle) stability.

Aimpoint AB

Jägershillgatan 15
SE- 213 75 Malmö, Sweden
Phone: +46 (0)40 671 50 20
Fax: +46 (0)40 21 92 38
e-mail: info@aimpoint.se

Aimpoint Inc.

7309 Gateway Court
Manassas, VA 20109, USA
Phone: +1 703-263-9795
Fax: +1 703-263-9463
e-mail: info@aimpoint.com

WWW.AIMPOINT.COM

© 2019 Aimpoint AB. [15568-1]

